

Gewenten 43a  
4704 RE Roosendaal  
The Netherlands  
T +31 (0)165 51 07 77  
info@creative-products.nl  
www.creative-products.nl

Installation movie  
**Lounger L**  
<http://bit.ly/installationLoungers>



# LOUNGER L INSTALLATION

VERSION 3.1

# BOX CONTENTS

## LOUNGER L

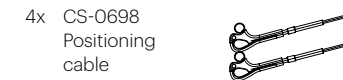
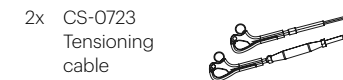
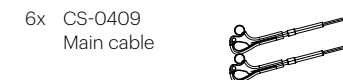
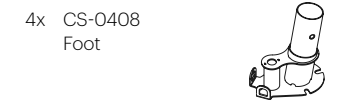
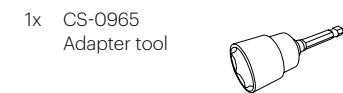
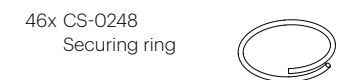
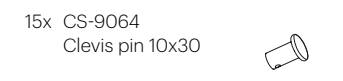
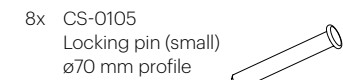
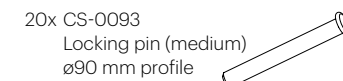
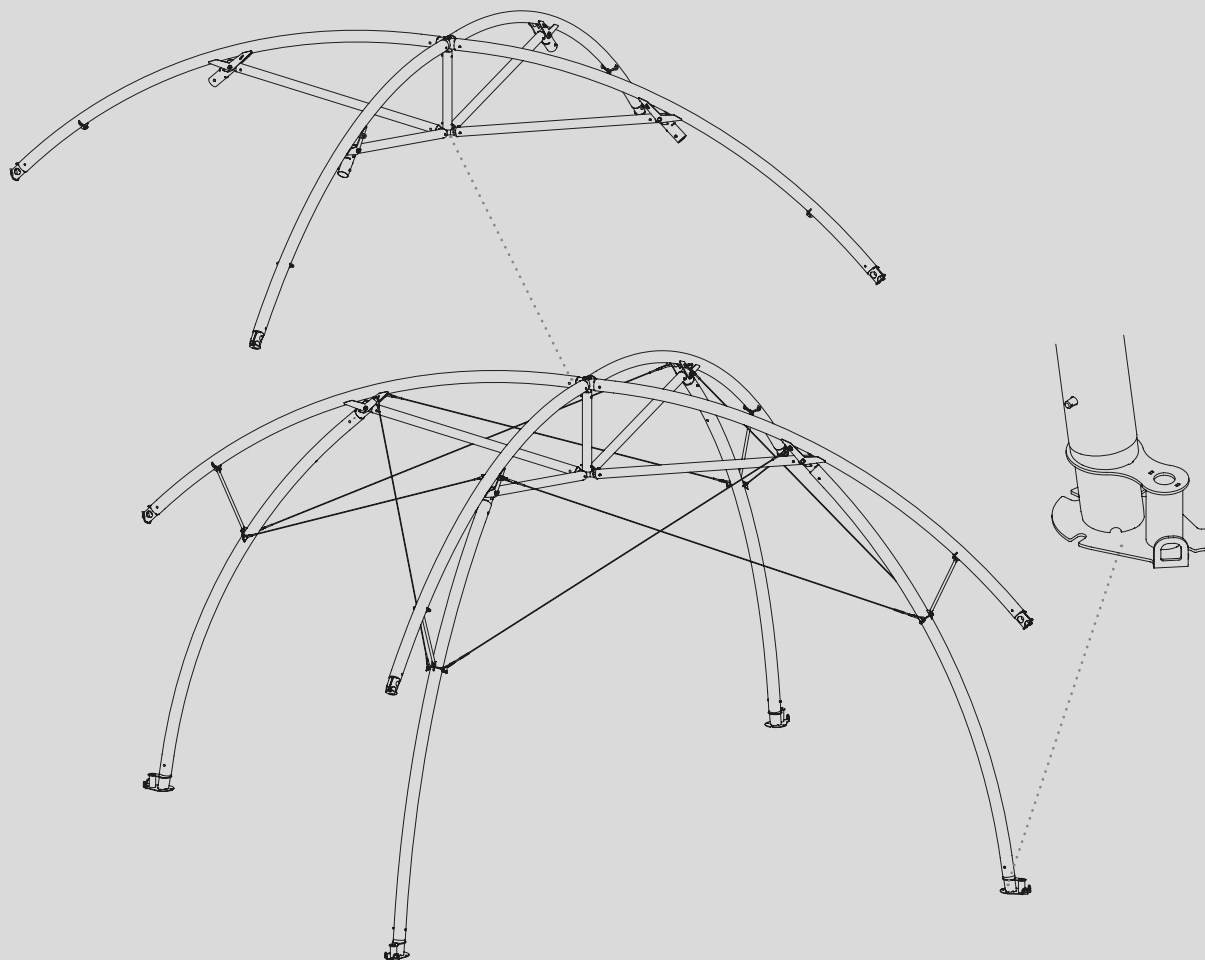
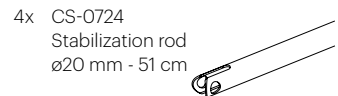
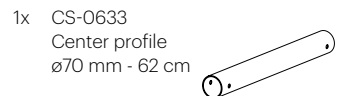
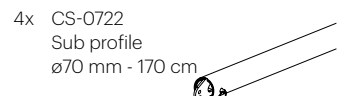
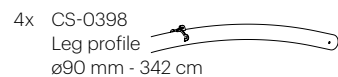
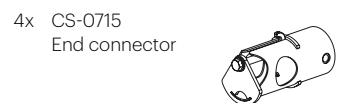
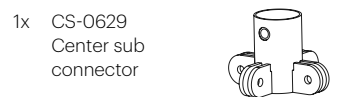
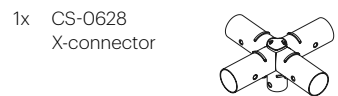
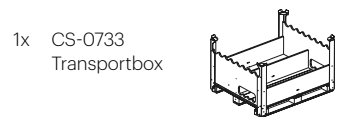

## STEP 1

Connect CS-0715 End connectors to the CS-0721 Roof profiles by using the CS-0093 Locking pin medium and CS-0248 Securing ring.

Connect it on the side where the rigging points for the cables are.

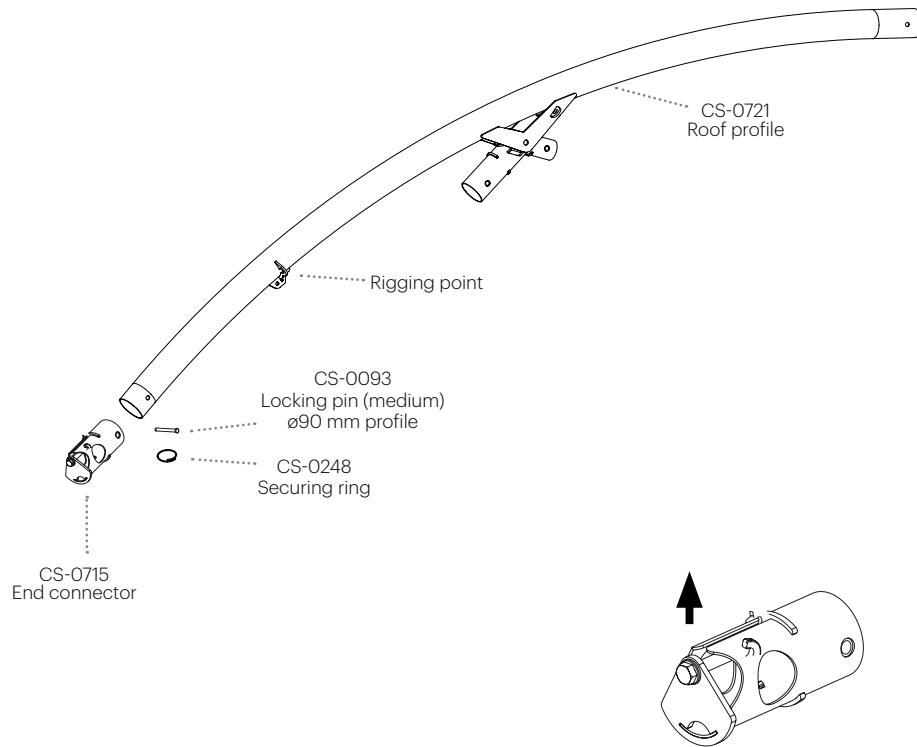

**!** PLACE THE TENSION HOOK ON THE CS-0715 UP RIGHT IN THE ROOF PROFILE

## STEP 2

Connect all 4 CS-0721 Roof profiles on the CS-0628 X-connector using the CS-0093 Locking pins medium and CS-0248 Securing rings.

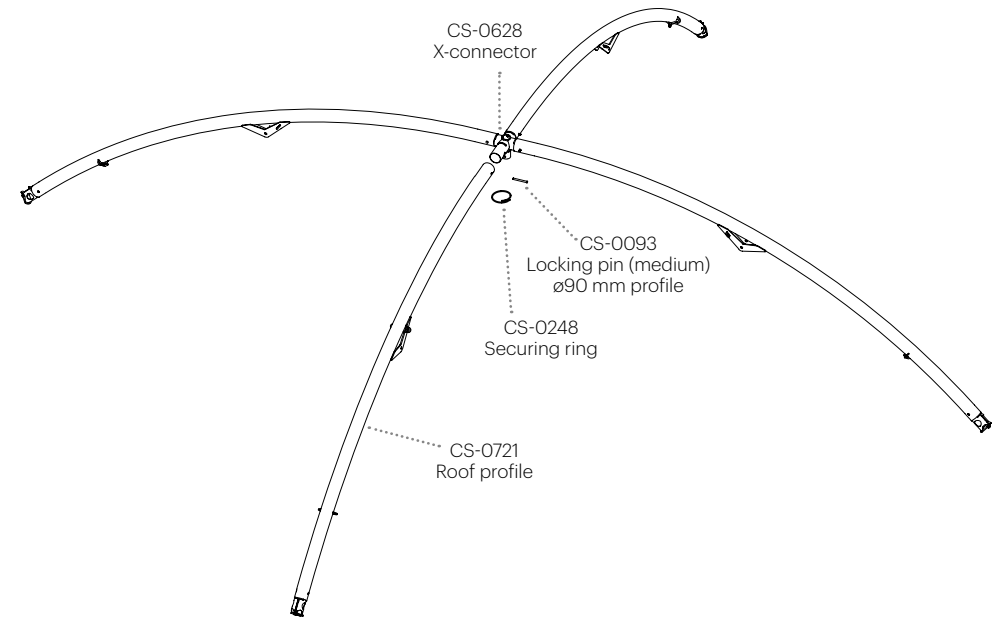

## STEP 3

Connect the CS-0633 Center profile in the middle of the CS-0628 X-connector.

Place the CS-0629 Center sub connector on the other side of the CS-0633 Center profile using the CS-0105 Locking pin small and CS-0248 Securing ring.

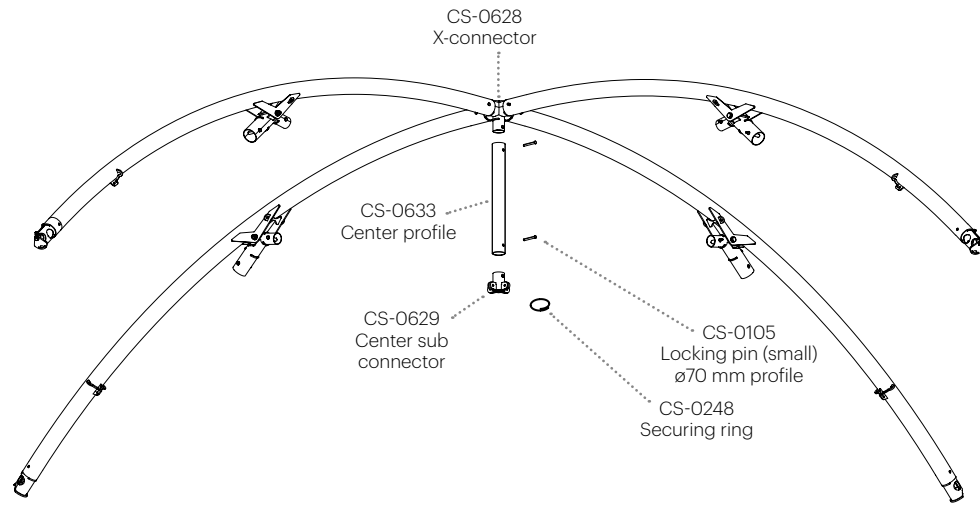

## STEP 4

Connect all 4 CS-0722 Sub profiles on the 4 CS-0721 Roof profiles using the CS-0105 Locking pins small and CS-0248 Securing rings.

Place the other end of CS-0722 Sub profiles on the CS-0629 Center sub connector with the CS-9064 Clevis pin and CS-0248 Securing ring.

If these parts are connected, you have finished the roof of the Lounger Large.

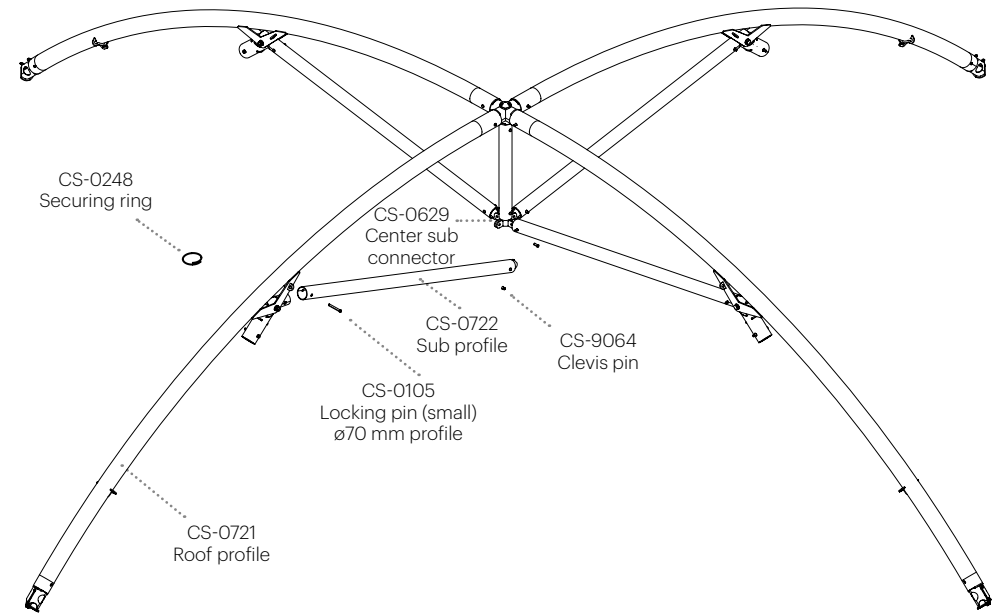

## STEP 5

Connect the 4 CS-0408 Feet to the 4 CS-0398 Leg profiles with the CS-0093 Locking pins medium and CS-0248 Securing rings.

Please note that the blind rivet nut is on the top of the tube.

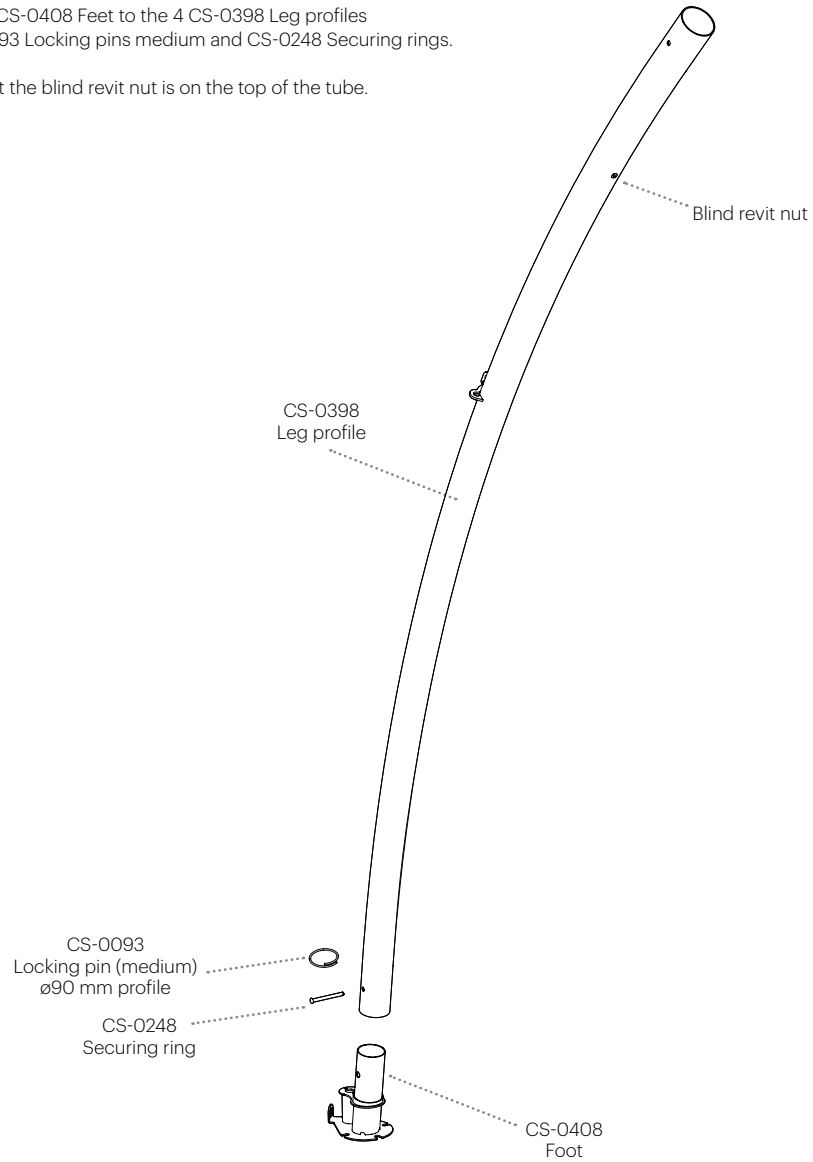

## STEP 6

Lift one side of the roof structure (if you ordered a Tripod; place the Tripod in the corner under the roof structure) and place **2** tubes CS-0398 Leg profiles on the roof structure using the CS-0093 Locking pins medium and CS-0248 Securing rings.

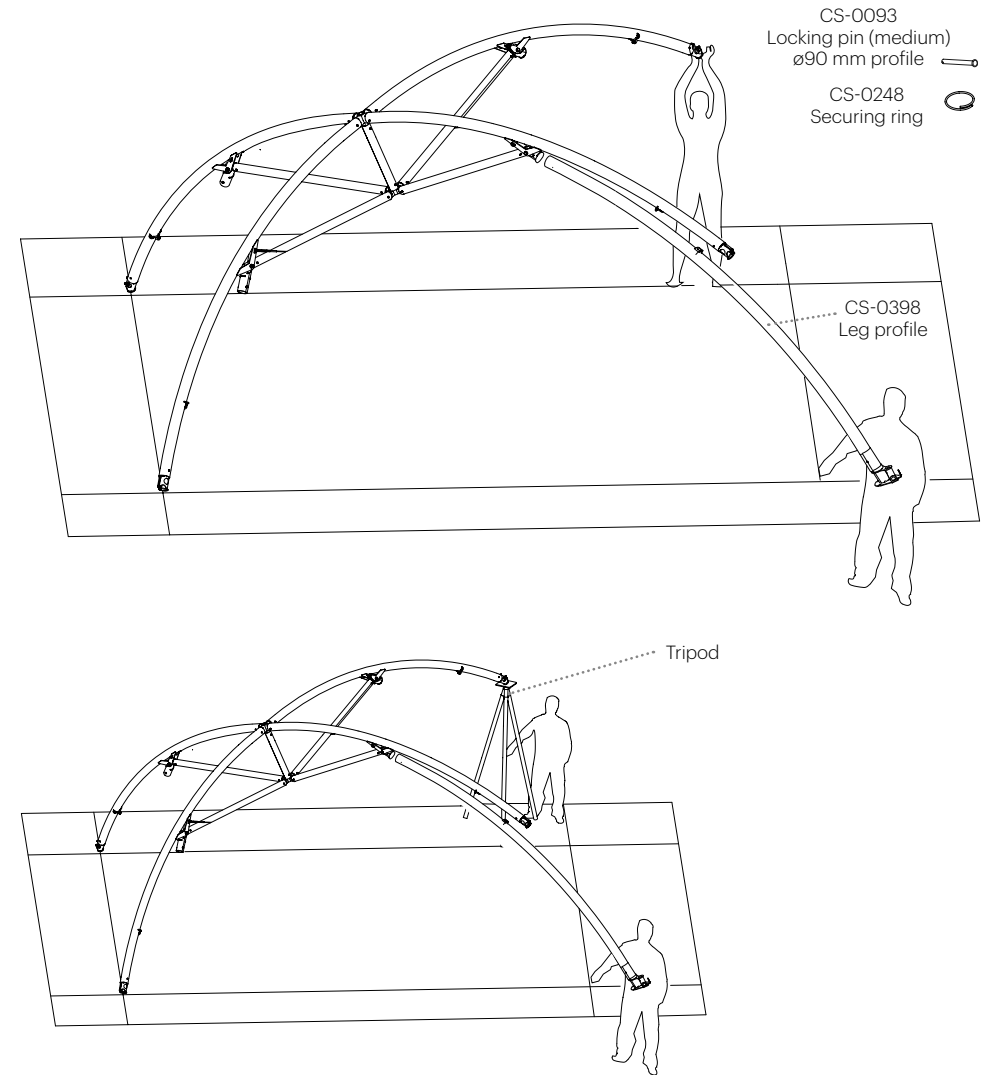

## STEP 7

Place **2** CS-0409 Main cables on one side of the structure and connect them as a cross to the CS-0398 Leg profiles.

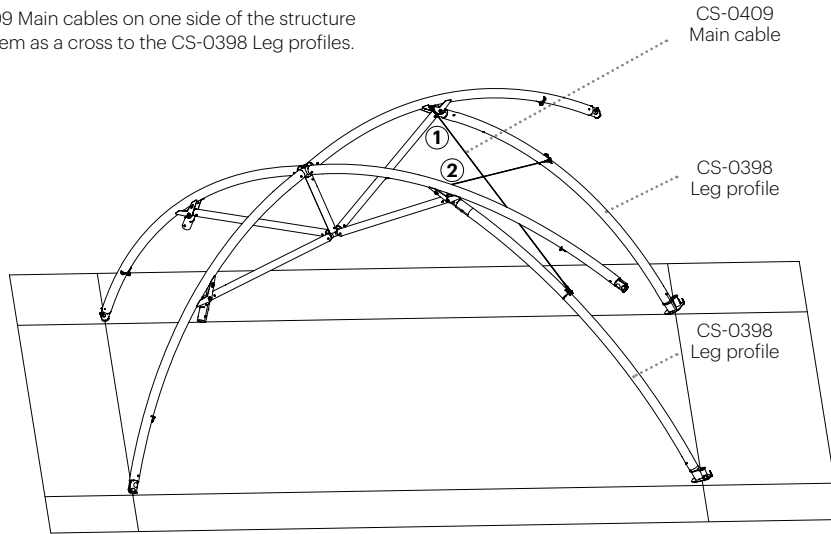

## STEP 8

Place the **2** CS-0723 Tensioning cables parallel on the roof structure and the 2 CS-0398 Leg profiles, with the tensioner at the leg. These cables will put tension on the structure later in the build.

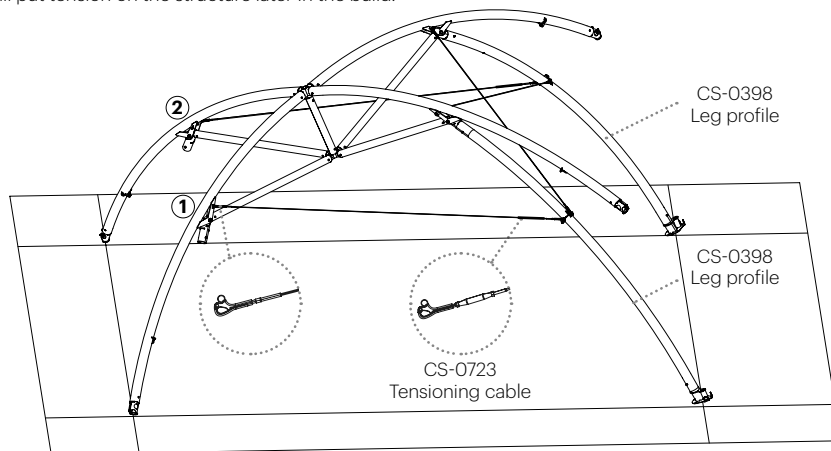

## STEP 9

Connect the other **4** CS-0409 Main cables to the CS-0721 Roof profiles.

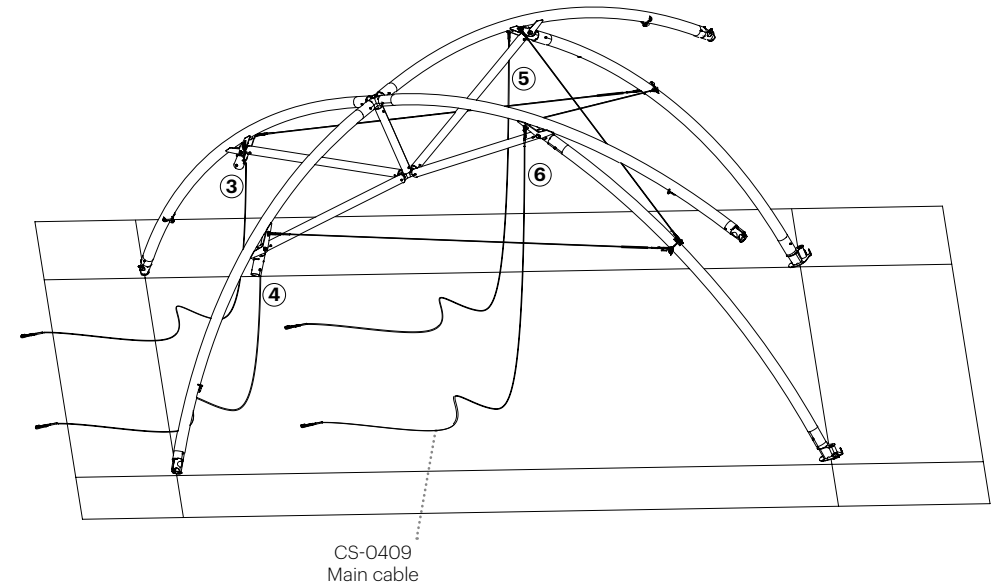

## STEP 10

Place the **4** CS-0724 Stabilization rods on the CS-0721 Roof profile with the CS-9064 Clevis pins and CS-0248 Securing rings.

Do not connect to the CS-0398 Leg profiles yet.

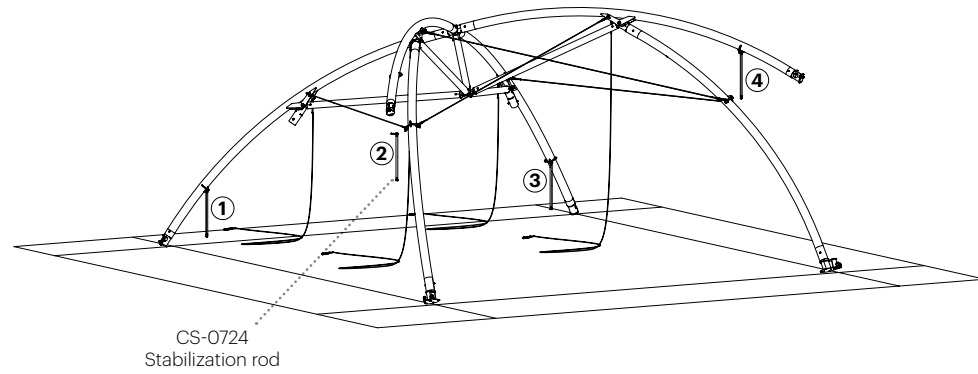

## STEP 11

Place the roof cover over the structure.  
On the side where the Leg profiles have been mounted you attach the metal hooks on the CS-0715 End connector.

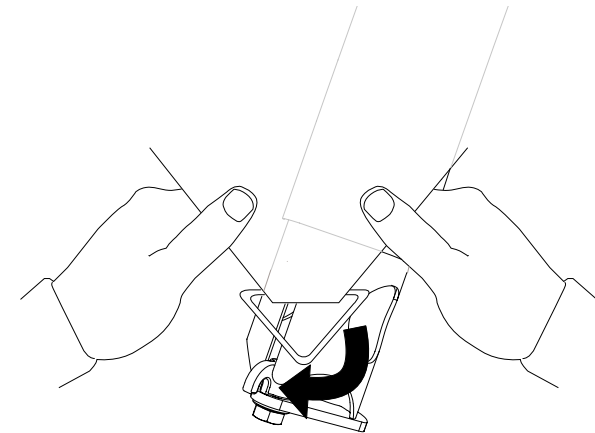
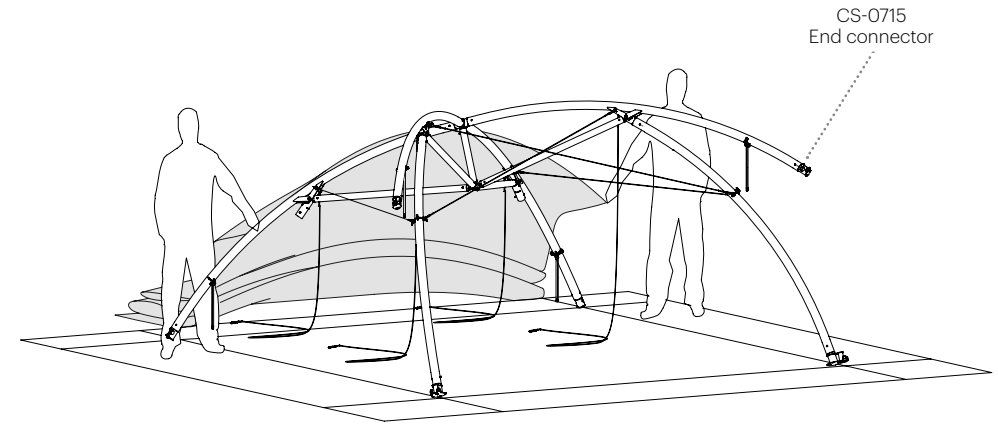

## STEP 12

Now lift the other side of the structure  
(if you ordered a Tripod place the Tripod in the corner under the roof structure)  
and place the last **2** CS-0398 Leg profiles on the roof structure  
with the CS-0093 Locking pins medium and CS-0248 Securing rings.

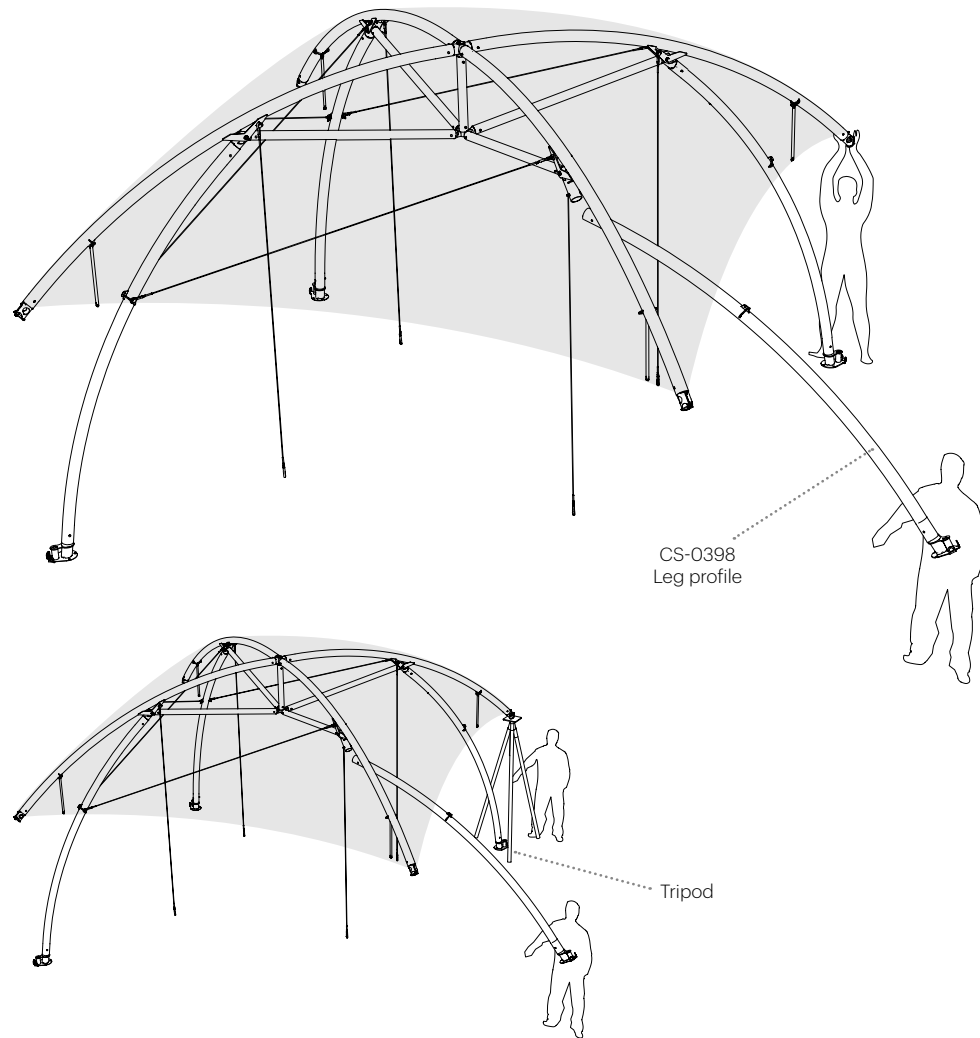

## STEP 13

Connect the last **4** CS-0409 Main cables to the CS-0398 Leg profiles (as in step 8).  
Every opening between the legs shows crossed cables.





## STEP 14

Connect the **4** CS-0724 Stabilization rods which were already attached to the roof to the CS-0398 Leg profiles using CS-9064 Clevis pins and CS-0248 Securing rings.

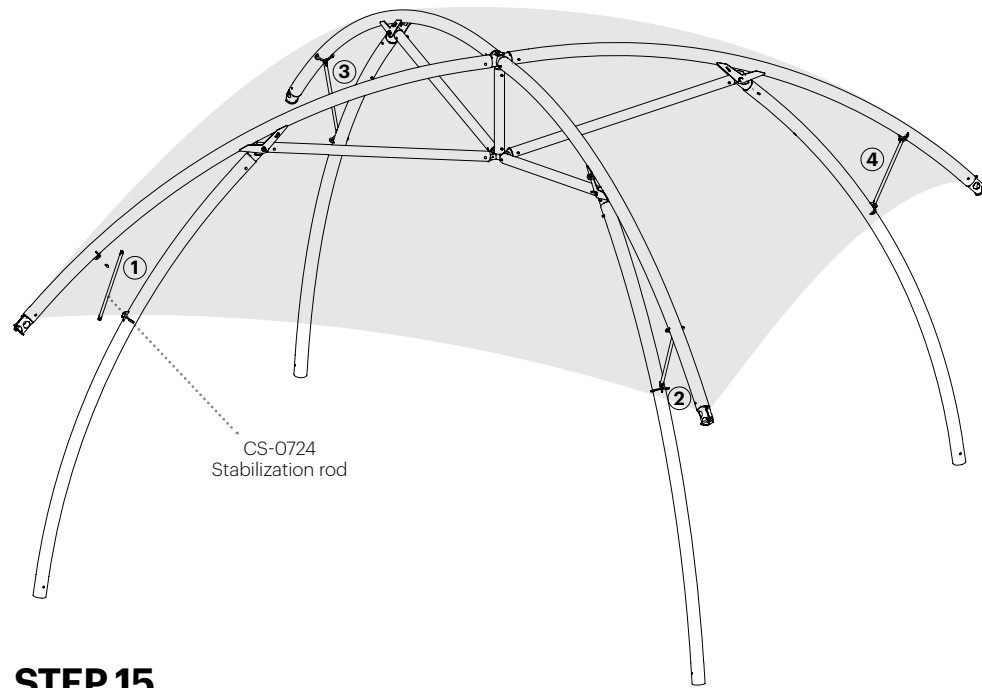

## STEP 15

Place the cover over the **2** remaining CS-0715 End connectors.

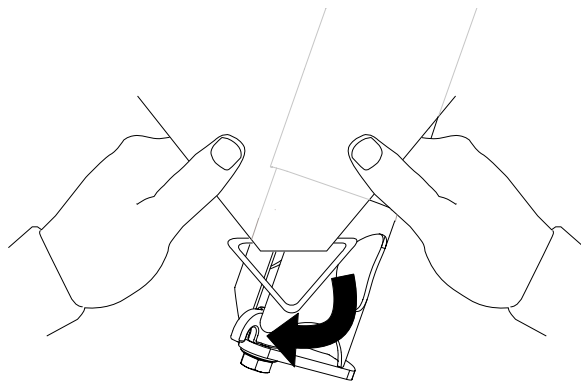

## STEP 16

Connect the **4** CS-0698 Positioning cables on the feet. Place the feet in the right position and anchor the structure to the ground.

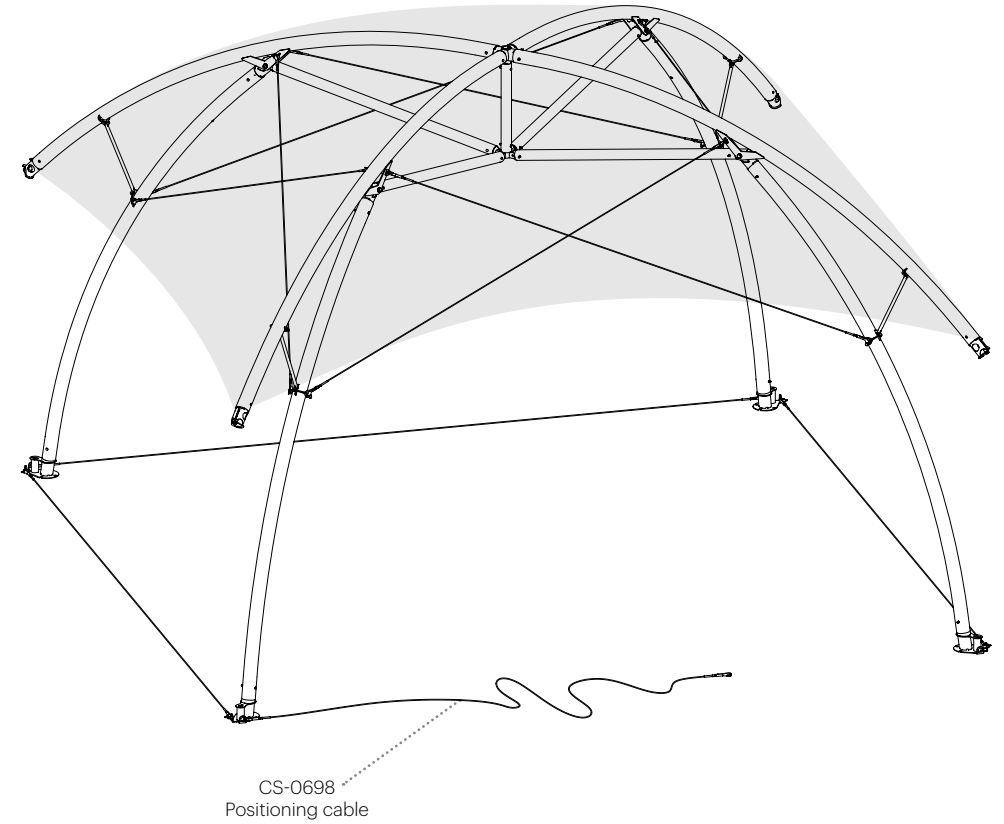

## STEP 17

### ANCHORING & BALLAST

There are three options for anchoring & ballast: 1 Ground pins, 2 Concrete screws, 3 Ballast plates.

**After** the structure has been anchored remove the CS-0698 Positioning cables.

#### CONCRETE SCREWS

Anchoring for permanent fixation on a hard surface (when drilling is allowed).

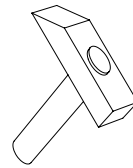
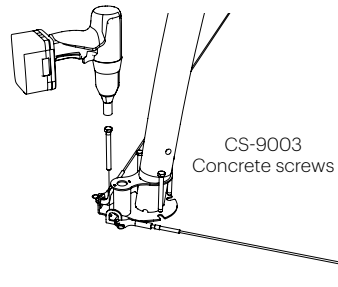

#### GROUND PINS

Anchoring for permanent fixation on soft ground (gras / sand / gravell).

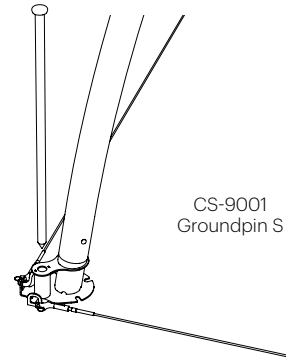

#### BALLAST PLATE OUTSIDE

The ballast plates can be used when drilling or the use of groundpins is not allowed.

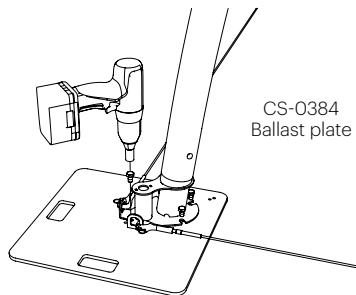

#### BALLAST PLATE INSIDE

The ballast plates can be used when drilling or the use of groundpins is not allowed.

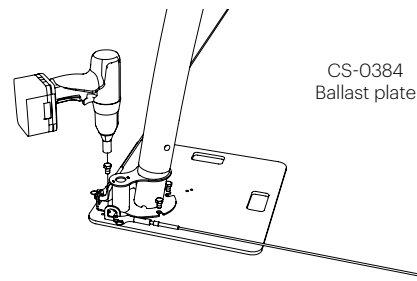

## STEP 18

Put tension on the CS-0723 Tensioning cables.

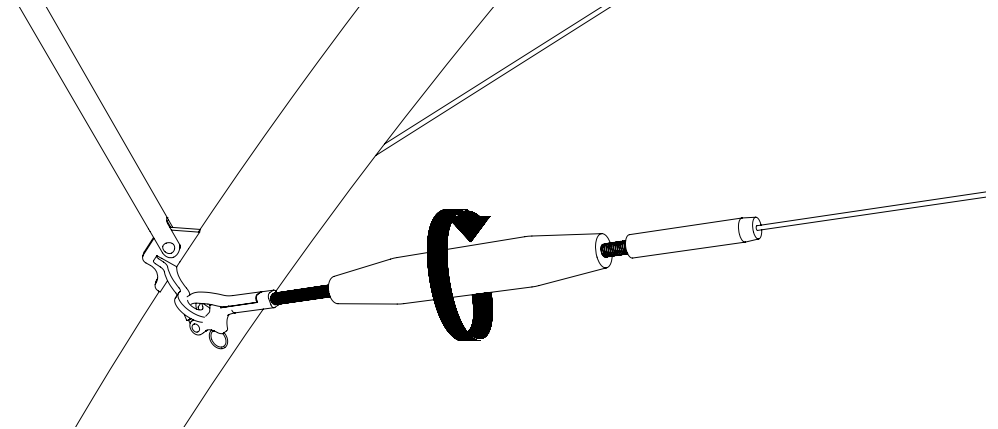

## STEP 19

At last put the cover on full tension at the CS-0715 End profiles by using the CS-0965 Adapter tool on the drill.

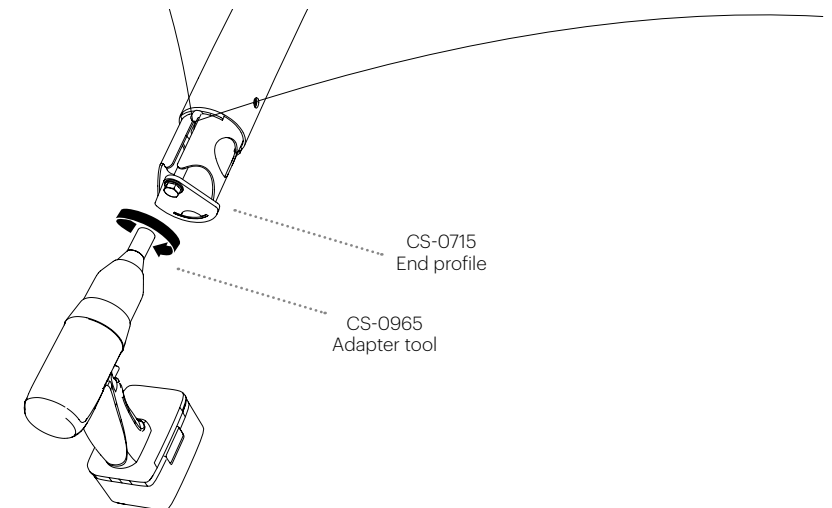

## STEP 20

### SIDEWALLS

First tension the roof. After that you can install the sidewalls.  
Connect the top-left and top-right corner of the sidewall with the pelicanhook in the corner of the CS-0721 Roof profile.  
Then connect bottom-left and right corner with CS-0634 connector.  
Put tension on the sidewall by using the drill.

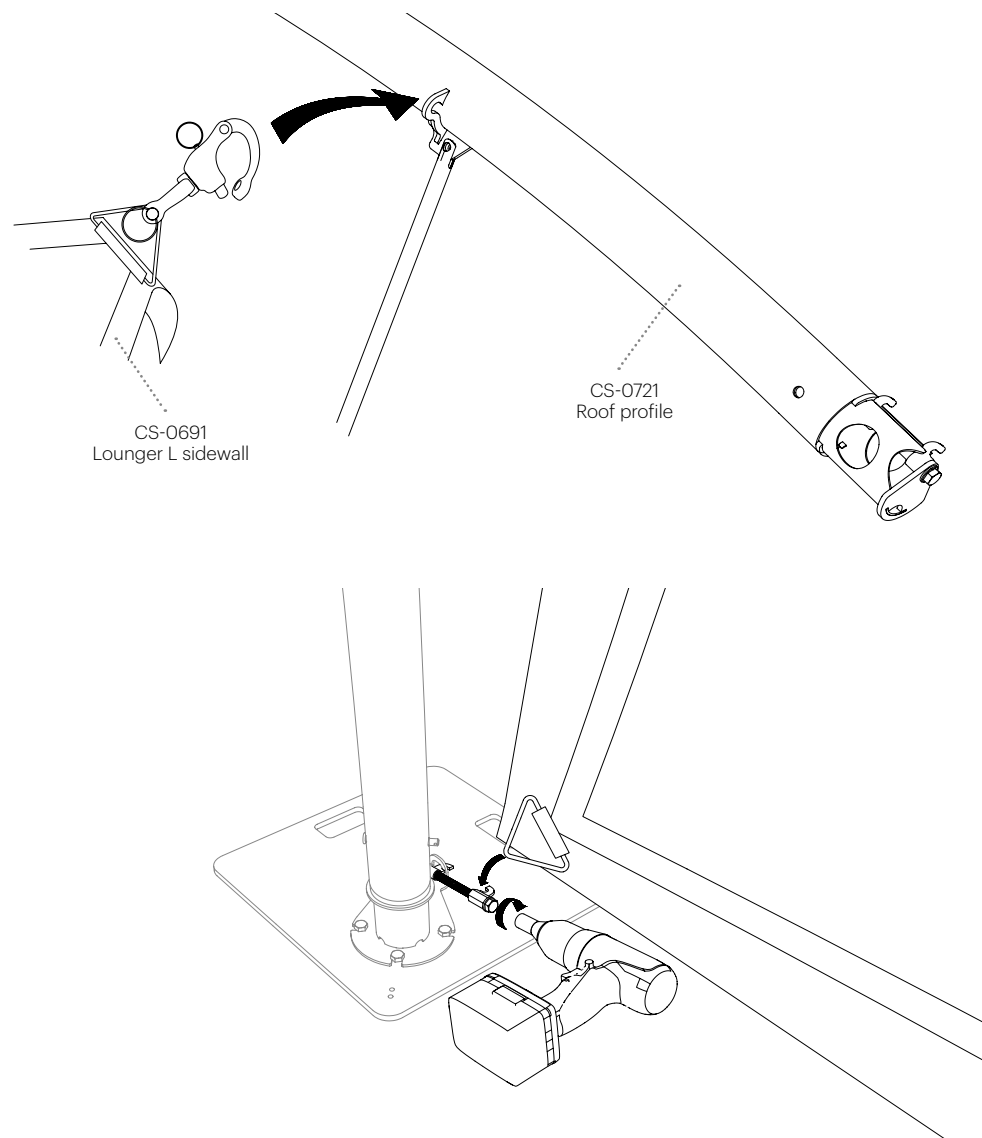

## STEP 21

For mounting (by example lights or television) use the blind revit nut, on the inside of the structure.  
It is possible to mount up to 25 kg per leg.

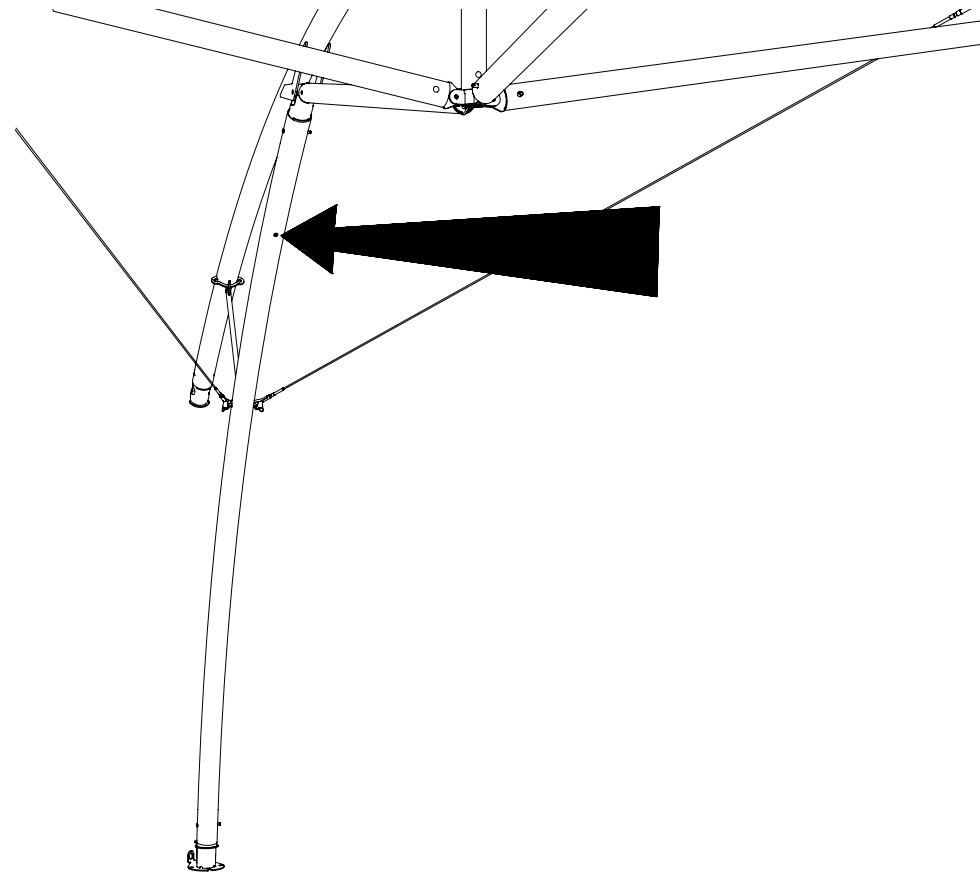

## STEP 22

When you take down the structure first take off the tension of the cover. Then take the tension off the cables and release the stabilization rod. Then it's a reverse build from step 14 till step 1.

## STEP 23

Packing manual for the Lounger Large Transport box.

### STEP 23.1

1x CS-0733 Transport box  
Please make sure that CS-0715 has been taken out of the tube CS-0721 to prevent transport damage. Put the 4 CS-0408, 4 CS-0715 and 1 CS-0628 in the transport box compartment A.

Place all 4 CS-0398 Leg profiles on top of the transport box take compartment A.

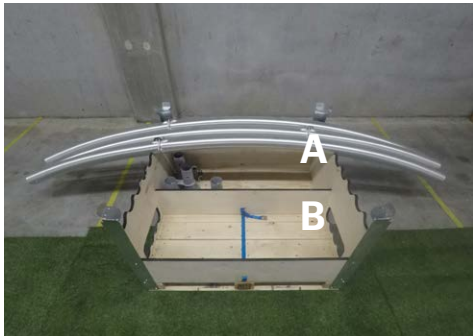

### STEP 23.2

Place the CS-0722 sub profile in compartment B between the 4 holes on the sides of the transportbox. Leave the small connectors in the profile. Put the CS-0633 next to the CS-0722 sub profile. If all the profiles are in place strap it with the supplied strap on the transportbox.

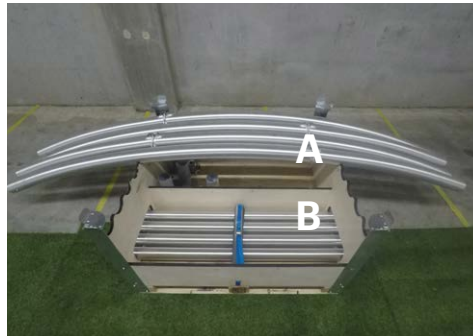

### STEP 23.3

Place the 4 CS-0721 Roof profile above compartment B.

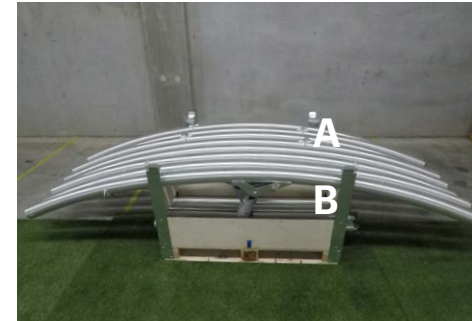

### STEP 23.5

Place the toolbox in compartment A next to the connectors..



### STEP 23.4

In the included Toolbox you need to put the next parts:  
4x CS-0724 Stabilization rod ø20 mm - 51 cm  
20x CS-0093 Locking pin (medium)  
8x CS-0105 Locking pin (small)  
15x CS-9064 Clevis pin 10x30  
46x CS-0248 Securing ring  
1x CS-0965 Adapter tool  
6x CS-0409 Main cable  
2x CS-0723 Tensioning cable  
4x CS-0698 Positioning cable  
1x CS-0629 Center sub connector.



### STEP 23.6

Connected the straps on each side of the transportbox over the metal bars and secure the profiles.

Now you are ready for transportation.

